

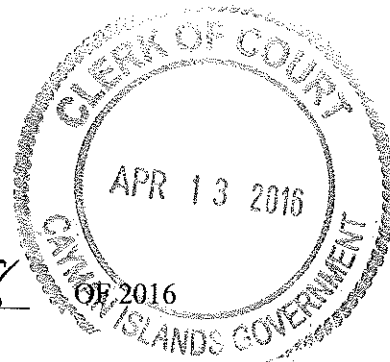

IN SUMMARY COURT AT GEORGETOWN

CAUSE NO. S0098



BETWEEN

Andy's Rent a Car

Plaintiff

AND

Sophia McDermott

Defendant



To the Defendant

**Sophia McDermott
34 Greenwood Drive, Prospect
Georgetown**

THIS PLAINT has been issued against you by the above –named plaintiff in respect of the claim set out on the next page.

Within 14 days of the service of this Plaintiff on you, counting the day of service, you must either satisfy the claim or return to the Court Office, P.O Box 495 George Town, Grand Cayman, the accompanying Acknowledgement of Service Form stating therein whether you intend to contest this action. If you intend to defend the action, in whole or in part, you must set out **full particulars of your defense** in the space provided in the Acknowledgment of Service Form.

If you fail to satisfy the claim or fail to return the Acknowledgement of Service Form containing full particulars of your defense, the Plaintiff may apply for **default judgment** without any further notice to you.

Issued this 12th day of April 2016.

PARTICULARS OF CLAIM

1. The Plaintiff resides at #370 West Bay Road, Seven Mile Beach.
2. The Defendant resides at 34 Greenwood Drive Prospect, Georgetown.
3. The Plaintiff claim against the defendant is for payment of the principal sum of CI\$5600.00 owed to him due to outstanding balance for damages to his rental Suzuki Liana motor car reg #155924

PARTICULARS

1. On Saturday 13th February, 2016 the Plaintiff and Ms. Shirley Jordan entered a written Contract on Thursday October 1st, 2015 for the Leasing of Suzuki Liana motor car #155924 in its present condition 10 years old for CI\$5000.00 or US\$6027.77. (See Attachment)
2. The agreement was that Ms. Shirley Jordan would pay a deposit of CI\$1500.00 upon entering the contract; thereon after Ms. Jordan would pay CI\$400.00 every month for nine months until her contract is finished.
3. On Saturday 13th February, 2016. Ms. Shirley's daughter Jordana Jordan who is an authorized driver for her vehicle #155924 had gotten into an accident by the traffic light on North Sound Road. Ms. Jordan's motor car Reg #155924 was struck from right front fender causing severe damage leading up to half of the front of the car which was caused by the Defendant who was driving Honda Acura Reg# 142453.
4. Ms. Jordan came out of the vehicle reg#155924 and met with the Defendant. Ms. Jordan then took out her cell phone and attempted to call her mother Ms. Shirley Jordan to inform her of the accident when the Defendant slapped Ms. Jordan's phone out of her hand not once but three times demanding her not to get anyone else involved.
5. An unknown witness called the police and PC#214 Emmanuel Brown attended the scene stated that the Defendant was at fault for the accident. Ms. Jordan then called her mother Ms. Shirley Jordan to come to the scene.
6. Ms. Jordan stated to PC#214 Brown that she was travelling along North Sound Road and went straight through an amber light passing Jacques Scott when the Defendant

who was coming from the opposite direction whilst turning right to go onto Shedden Road collided with her vehicle Reg#155924. The Defendant claims that Ms. Jordan was at fault as her light was on green.

7. Upon questioning the Defendant, PC #214 Brown noticed that the Defendant's vehicle License and Driver's License was expired and told her that she would be taken to the George Town Police Station. The Defendant in a state of panic pulled her pants down and urinated in the presence of PC#214 Brown. PC#214 Brown instructed both parties to report back to the Plaintiff's Office as soon as possible.
8. Ms. Jordan told her mother Ms. Shirley Jordan who arrived on the scene that her chest and her right ankle were in pain. Ms. Shirley took her to the George Town Hospital after PC#214 Brown had arrested the Defendant.
9. On Monday 15th February 2016, Ms. Jordana Jordan went to the Plaintiff's office filled out an incident report and also gave the Plaintiff a photo of Ms. Jordana at the Georgetown Hospital Accident and Emergency Department on Crutches with her ankle bounded and also receipts from the hospital.(See Attachments)
10. On Wednesday 17th February, 2016 Mr. Collin Redden who was the adjuster for the Plaintiff's vehicle Reg# 155924 looked at the vehicle which was towed to Andy's Auto to do an appraisal which the Plaintiff received on the Thursday 10th March, 2016. Mr. Redden's appraisal states that the Plaintiff's vehicle Reg#155924 was declared as an economical write off.(See Attachment)
11. On the Friday 19th February the Plaintiff received a towing invoice. (See Attachment)
12. On Wednesday 9th March, 2016 the Plaintiff called Ms. Earldene Omeria Gordon asking for a phone number for the Defendant as the Defendant had previously written off Ms. Gordon's rental Reg#156071 from the Plaintiff on Friday 13th November 2015. The Defendant took Ms. Gordon's rental Reg#156071 without her consent, wrote off the said vehicle and was arrested for DUI. Plaintiff obtained a phone number for the Defendant from Ms. Gordon.
13. On Wednesday 9th March, 2016, The Plaintiff called the Defendant to come in to fill out the paperwork. The Defendant stated that she would come in on this day as she has a very flexible schedule however she did not come. The Defendant allowed the Plaintiff to use Whatsapp as an alternative means of contact for her. The Defendant also applied for a police report on this day(See Attachment)
14. On Tuesday 15th March, 2016 the Plaintiff called the Defendant once again asking her to come in. The Defendant said she would come by but she did not show up.

15. On Tuesday 22nd March 2016, The Plaintiff messaged the Defendant via Whatsapp asking her to come in. The Defendant is receiving the messages but is not responding. The Plaintiff has also sent out a message to the Defendant on Tuesday 29th but no response. (See Attachment)
16. On Wednesday 30th March 2016 the Defendant messaged the Defendant via Whatsapp asking her to come in. The Defendant replied that she would try to come in but didn't show up.
17. On Thursday 31st March,2016 the Defendant messaged the Plaintiff via Whatsapp asking the time that the Plaintiff closes his Office which the Plaintiff did respond to the Defendant informing her that the rental location on Seven mile Beach closes at 5:00pm and that he was not in office until the following day from 8:00am to 1:00pm. The Defendant that she will try her best to come in between that time.
18. On Wednesday 6th April, 2016 the Plaintiff messaged the Defendant via Whatsapp asking her to come in on Thursday 7th April or Friday 8th April, 2016 but the Defendant didn't respond.

AND the Plaintiff claims:

1. The sum of CI\$5350.00
2. Fixed cost of CI\$250.00
3. Alternative cost to be assessed.

Plaintiff's Signature

Plaintiff's Address for service

P.O Box 127 Hell
West Bay, KY1-1401

IN THE SUMMARY COURT AT GEORGE TOWN

CAUSE NO. OF 2016.

BETWEEN Andy's Rent a Car Plaintiff

AND Sophia McDermott Defendant

ACKNOWLEDGEMENT OF SERVICE

1. State the Defendant's name and address

Sophia McDermott
#34 Greenwood Drive, Prospect

2. State whether the Defendant intends to contest the action

Yes No

3. If you do intend to contest this action, do you want time in which to pay this claim?

Yes No

Service of Plaintiff is acknowledged accordingly.

(Signed) _____

Defendant's Signature

Date this _____ day of _____, 2016.

PARTICULARS OF DEFENSE

(Here set out in numbered paragraphs the grounds upon which the defendant says that he is not liable to the Plaintiff, or is not liable for the full amount claimed)

Defendant Signature

REMINDER- This form must be taken or sent to the Court Office, P.O Box 495GT, George Town, Gran Cayman within 14 days of receipt otherwise a Default judgment may be entered against you.

Notes on address for Service

Attorney: Where the Defendant is represented by an attorney, state the attorney's place of business in the Cayman Islands. A Defendant may not act by a foreign attorney.

Defendant in person: Where the defendant is acting in person, he must give his post box number and physical address of his residence or, if the Defendant does not reside in Cayman Islands, he must give an address in Grand Cayman where communication for him should be sent. In the case of a limited company, "residence" means its registered principal office.

Endorsement by Plaintiff's attorney (or by Plaintiff if suing in person) of his name and address and reference, if any in the box below.

Andy's Rent a Car #370 West Bay Road, Seven Mile Beach Grand Cayman
--

Endorsement by Defendant's Attorney (or by Defendant if suing in person) of his name, address and reference, if any, in the box below.

--

Date this _____ day of _____, 2016.

Andy's Rent a Car
Plaintiff

ISSUED by Andy's Rent a Car of #370 West Bay Road, Seven mile Beach, Grand Cayman.

PO Box 167 Hill
West Bay
Grand Cayman KY-1-1401
Cayman Islands



CAR RENTALS, LEASING & SALES
At Andy's Your 7th consecutive day
renting is ALWAYS FREE!

Phone: 340-940-8111
Fax: 340-949-8886
E-mail: reservations@andy's.com

RENT-TO-OWN AGREEMENT

152-87

This RENT-TO-OWN AGREEMENT (hereinafter referred to as the "RTO") is made on this 2ND day of
October _____, 2015 by and between the following parties:

Shirley Joy Jordan and ANDY'S RENT-A-CAR LTD
(hereinafter referred to as "Buyer"); (hereinafter referred to as ARAC).

In consideration of the mutual promises herein, the parties hereby agree as follows:

- 1) DESCRIPTION: ARAC agrees to sell/or rent, and the Buyer agrees to buy/or rent the following motor vehicle (hereinafter referred to as the "Vehicle"):

Plate #: 155924 Model: Suzuki Liana Year: 2005 Color: Lt. Blue

VIN# RA31S-250047

Purchase Price: CI \$4,300.00 Insurance & Licensing fee \$ 700.00 (nine months Only)

Down Payment: \$ 1500.00 Balance to be Financed: \$ 3,500.00

- 2) TERM: The term of this RTO shall be for a period of Nine (9) months

commencing on October 30th, 2015, and ending on June 30th, 2016.

PAYMENTS: Buyer promises to pay ARAC CI\$400.00 per month on the 30th of
each month for a total of nine (9) months.

A late charge of CI\$ 20.00 will be applied for any payment that is five (5) days late.

70, 50, 107 Hill
West Bay,
Tortola, Cayman Islands



CAR RENTALS, LEASING & SALES
*At Andy's Your 7th consecutive day
renting is ALWAYS FREE!*

Phone: 345-939-9111
Fax: 345-939-8395
E-mail: andy@andyandcars.com

- 8) **COVENANTS OF BUYER:** Commencing with entering the term of this agreement, including extensions, the Buyer hereby covenants and agrees as follows:
- a) That the Buyer must pay all vehicle related charges and bills, including, but not limited to vehicle repairs, damages as a result of vehicular accidents or Buyer negligence, any third-party damages or claims involving the Vehicle which are not covered by our third party insurance provider Saxon MG.
 - b) That the Buyer must not use, nor permit any persons to use, Vehicle for any unlawful purpose and that the Buyer will conform to and obey all laws, ordinances, rules, regulations, requirements and orders of the Laws of the Cayman Islands. Failure to do so may result in immediate Vehicle repossession.
 - c) That buyer must inform ARAC of any change in address and/or change in residence, and place of employment. Failure to do so may result in immediate vehicular repossession.
- 9) **COVENANTS OF ARAC:** ARAC hereby covenants and agrees as follows:
- a) That ARAC shall pay for and maintain third-party coverage insurance on the Vehicle as required by Cayman Islands Law, for the authorized driver(s) only, for the term of the contract.
 - b) That ARAC will provide one (1) free full service to Vehicle.
- 10) **RIGHT OF ASSIGNMENT:** The Buyer may NOT lend, rent, transfer, or otherwise convey any rights of this RTO or Vehicle to any third party. Failure to adhere to this condition will result in vehicle repossession.

IN WITNESS WHEREOF,

the parties hereto, have set their hands to this Rent-To Own Agreement on this
22nd day of October, 2011

[Signature]
Buyer

[Signature]
Andy's Rent-A-Car

Witness _____

Buyer's Initials: _____
Andy's Rent-A-Car initials: _____

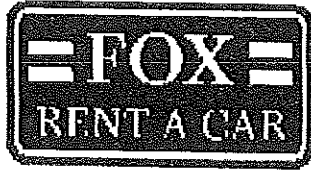

P.O. Box 127 Grand Cayman
 KY1-1401 Cayman Island
 Toll-Free: 1-855-691-3991
 Email : reserve@andys.ky

Rental Agreement #
7MB211351

Check Out by: GISELLE

RATES DO NOT INCLUDE COST OF FUELS

VEHICLE DEEMED TO BE STOLEN IF NOT RETURNED WHEN DUE OR ON DEMAND

RENTER
SHIRLEY JORDANA (RTO) Renter Not Driving? (initial box to right)

CELL PHONE HOME PHONE EMAIL
 (345)917-0336 SHIRJORDAN@HOTMAIL.COM

PERMANENT ADDRESS
 58 logwood way gt box 2654 gt

CITY PROV./STATE POSTAL CODE
 grand cayman GT

DRIVER'S LICENSE NO. PROV./STATE EXPIRES M D Y AGE
 61413 GT 04/22/2018

ORIGINAL VEHICLE		REPLACEMENT VEHICLE	
155924	VEHICLE NO.		
LIANA	MODEL		
	MAKE		
11.50	TIME AND DATE IN		
10/01/2015	TIME AND DATE OUT		
53,981	MILES OUT		
	MILES DRIVEN		
	MILES IN		
	FUEL OUT		0
	FUEL IN		0

3/8

RENTER IS LIABLE FOR ALL DAMAGE AND COSTS TO VEHICLE CAUSED BY A DRIVER NOT NAMED IN THIS AGREEMENT, EVEN IF RENTER HAS PURCHASED LDW.

ADDITIONAL RENTER SIGNATURE

DRIVERS LICENSE NO. EXPIRES M D Y AGE

RENTED FROM TO BE RETURNED TO
 7MB 7MB

TO BE PAID BY
 Corp. Account P.O. Number

MINIMUM RENTAL CHARGE: 24 HOURS (Unlimited Mileage)

Dent - X

Missing - O

Scratch - _

Right Renter's Initials

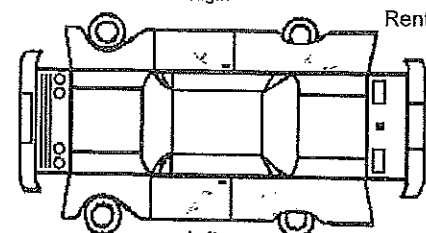

Left

DAMAGE COVERAGE

LDW Full Coverage Accept x Decline x

LDW \$2,400.00 Deductible Accept x Decline x

Third-Party Coverage Accept x Decline x

DECLINE ALL : You will be responsible for Full Value of vehicle

x Renter's Initials Full Value Limit

READ AGREEMENT BEFORE SIGNING!!
 I have read and agree to be bound by the terms and conditions on both sides of this Agreement. By signing below I am giving Andy's permission to charge my Credit Card, which is recorded on the Rental Agreement, for all charges incurred by this rental.

Payment Info:
 VI 44XXXXXXXXXX4104 400.00

DUE BACK DATE AND TIME: 10/03/2015 12.00 AM PM

I understand the rental extension cannot always be granted as vehicle may be reserved. I promise to return the vehicle when it is due in, unless it has been properly extended. Rates Change to / day after due in date.

x Renter's Signature

Description	#Charged	Rate	Charges
Hourly (sp)		8.30 /hour	.00
Net T&M			.00
Environment Recovery Fee2		.00 day	
Third Party	2	.00 /day	
Refuelling Charge (per Gallon		4.71	
Estimated Charges			.00
Deposit VI 44XX 4104			400.00
Total Deposits/Payments			400.00

PAYMENT DUE: - 400.00



email: jordana.jordan@live.com

Customer Profile

Driver's name: Jordana Jordan DOB: 11/30/1994

Address: 58 Logwood way. Phone:

Does the driver have motor insurance with another carrier? [] Yes [] No If yes, which company?

Did you admit liability? [] Yes [x] No Was the driver injured? [x] Yes [] No

If yes, please list nature of injury: Ankle pain & chest pain.

Cayman Driver's license #: 1255232 Issue date: Expiry date:

License type: [] GP0 [] GP1 [] GP1A [] GP2 [] GP3 [] GP4 [] GP5

Does driver have a foreign driver's license? [] Yes [] No If yes, which nationality

Driver's license #: Issue date: Expiry date:

Year: Make: Suzuki Model: Liana Color: Blue.

Registration #: 155924 Vin # (last four digits):

Date of accident: 01/13/16 Location of accident: Jacques Scott - street light

Time of accident: 7:50 [] A.M. [x] P.M. Objects involved in accident: 2 cars (Liana & Acura)

Speed at time of accident (mph): 35 (km): Weather conditions at time of accident: [] Clear [] Cloudy [] Rain

Road condition / visibility type: [x] Dry [] Wet [] Darkness [] Dawn [] Daylight [] Dusk [] Road Lighted [] Road Unlighted

Were headlights on? [x] Yes [] No Is the vehicle drivable? [] Yes [x] No Was the vehicle towed? [x] Yes [] No

Where is the vehicle now? Andy's Auto. How many passengers were in your vehicle? 0

Police present: [x] Yes [] No Name of police officer / badge: BROWN.

Was any other person injured? [] Yes [x] No

Passenger (1) Phone DOB:

Address: Nature of injuries:

Was injured taken to hospital? [] Yes [x] No Name of hospital:

Passenger (2) Phone DOB:

Address: Nature of injuries:

Was injured taken to hospital? [] Yes [x] No Name of hospital:

Statement #: 7385647

Account #: 148220	Amount Due: 0.00	Amount Paid:	<input type="checkbox"/> Check <input type="checkbox"/> Discover <input type="checkbox"/> Visa <input type="checkbox"/> MasterCard			
Statement Date: 04-01-2016	Date Due: 05-01-2016	Credit Card Number:	Exp. Date:			
		Signature: X _____				

Make Checks Payable and Mail to:

SHIRLEY JOY JORDAN-MYLES
 P O BOX 2654
 Grand Cayman KY1-1101
 CAYMAN ISLANDS, Grand Cayman

C.I. Health Services Authority
 P.O. Box 915
 Grand Cayman KY1-1103
 GRAND CAYMAN,

Please detach and return this portion with your payment.
 Please indicate any name and/or address changes on this form.

Inquiries call (345) 623-8600	Account #: 148220	Statement #: 7385647
-------------------------------	----------------------	-------------------------

Provider of Service	Date of Service	Service Provided/ Account Activity	Charges, Payments, Adjustments	Insurance Pending	Patient Balance	*R
Patient Name: JORDANNA ALICIA JORDAN						
Date of Service: 02-13-2016 Financial#: 3852806						
Grand Cayman						
	02-13-2016	co-dydramol Tab (500mg-10mg)	9.50	9.50		
	02-13-2016	ibuprofen 400 mg Tab	4.50	4.50		
	02-13-2016	Basic A&E Bed Supplies	6.00	6.00		
	02-13-2016	ER Crutches	17.00	17.00		
	02-13-2016	XR Ankle 2 Views RT	77.08	77.08		
	02-13-2016	XR Cervical Spine 2 Or 3 Views	111.06	111.06		
	02-13-2016	XR Chest Single View	40.00	40.00		
	02-13-2016	XR Foot 2 Views RT	79.34	79.34		
	02-13-2016	ER Level 3 Fee - 99283**	183.70	183.70		
		Visit Total:	528.18	528.18	0.00	
Unpaid Balance:				528.18	0.00	

Total patient payments and or co-payments applied since last statement: \$0.00

*R - Description of Remarks

CERNER OCN STATE1.1

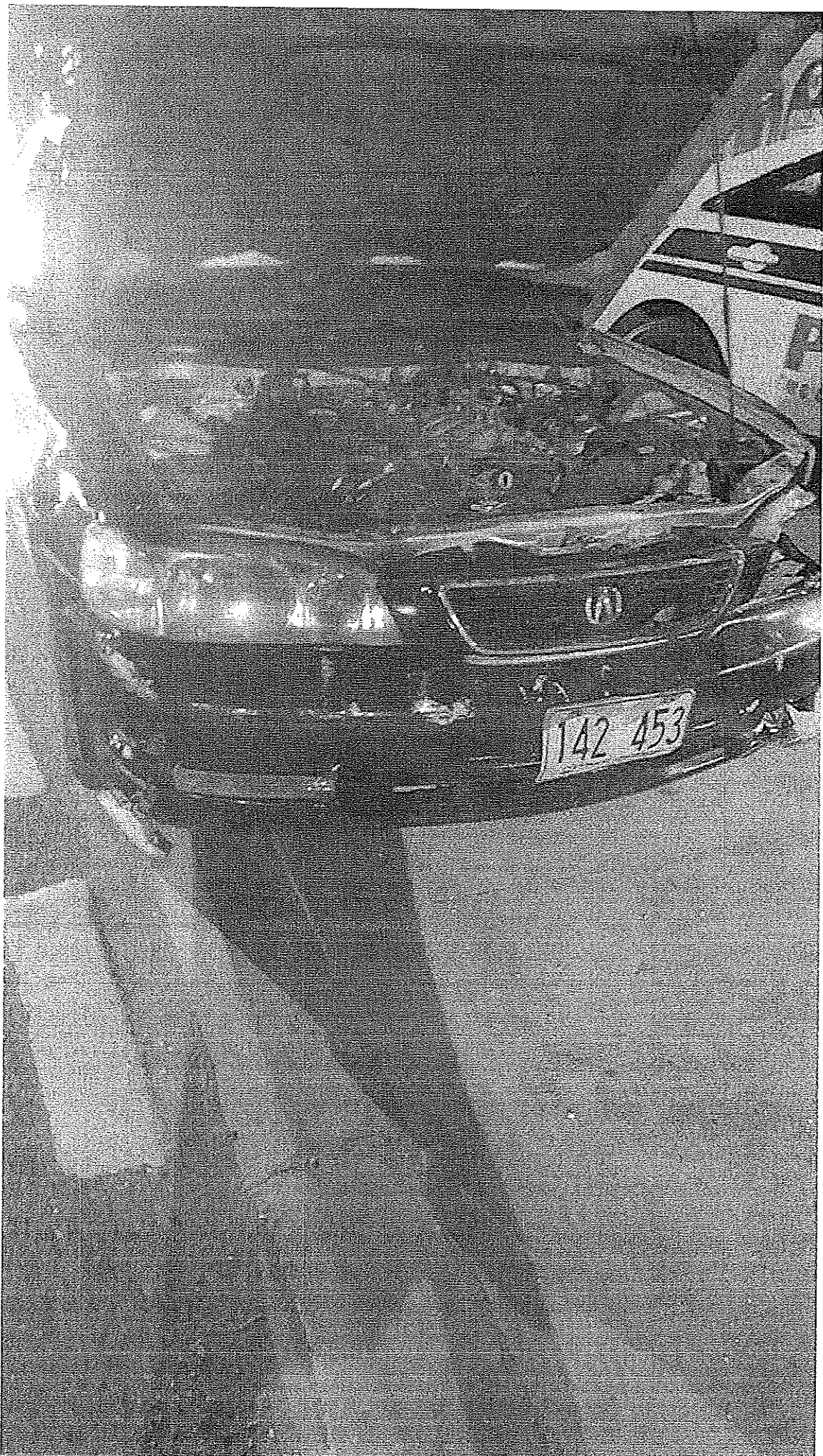



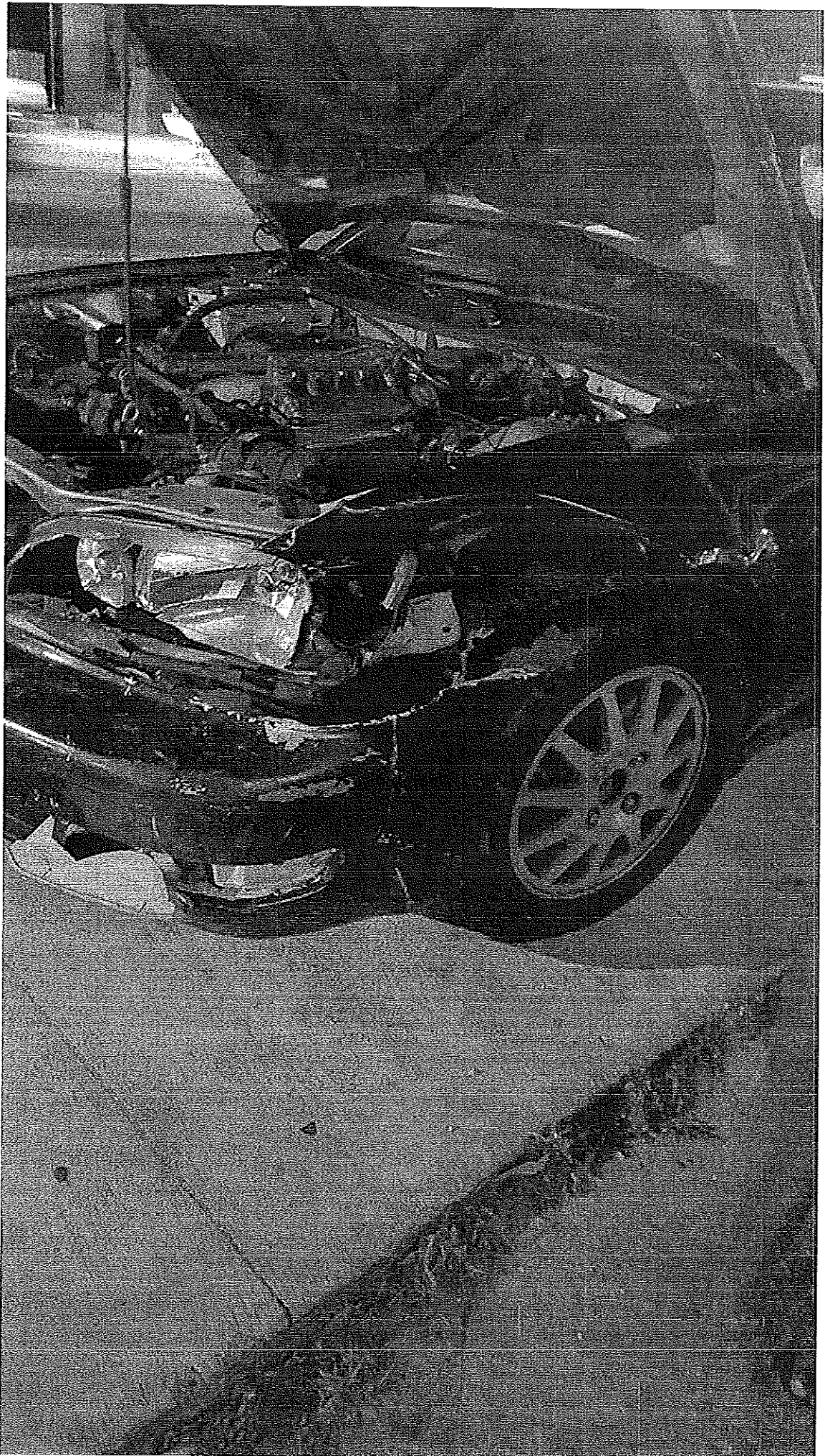

Andy's Auto LTD

Federal Tax ID: Over Sea's
 PO Box 127, 18 Joseph's Drive
 West Bay, KY1-1-401
 Phone #: 345-949-3391
 Fax #: 345-949-1546
 E-Mail: jerry@andys.ky

Customer No: 1656
 Report No: 1634
 Claim #:
 Assign No:

Estimate

2/19/2016

<u>Vehicle Information</u>	<u>Owner - Andys Rent A Car</u>	<u>Accident Location</u>
2005 Suzuki Liana	West Bay, KY1-1	
Style: 4-Door Car	Work Phone: 949-8111	
Color:	Work Phone:	Phone #1:
Color Code:	Fax #:	Phone #2:
Production Date: / 0	<u>Insured -</u>	<u>Claimant -</u>
License: 155924 State:	Home Phone:	Home Phone:
VIN: RA31S250047	Work Phone:	Work Phone:
Miles In: 0	Fax #:	Fax #:
Miles Out: 0	Date of Loss: 2/18/2016	Date of Inspection: 2/18/2016
Condition:		
Estimator: Gerald Parsons		
Date Assigned: 2/18/2016		

Description of Work	Part Number	Price	Labor	Paint	Other	
* Towing Service From Jacques Scott's to Andys Auto			2.5* mech*			
Sub Totals			2.5			
			Hours	Rate	Total	
			Mech Labor	2.5hrs	\$60.00/hr	\$150.00 T
			Tax	Non-Taxed		
Grand Total					\$150.00	

IN BUSINESS SINCE '83
 STATE LICENSE # 10237

THANK YOU FOR LETTING US SERVE YOU

T Indicates Taxed Item

Andy's Auto LTD

Federal Tax ID: Over Sea's
 PO Box 127, 18 Joseph's Drive
 West Bay, KY1-1-401
 Phone #: 345-949-3391
 Fax #: 345-949-1546
 E-Mail: jerry@andys.ky

Customer No: 1655
 Report No: 1633
 Claim #:
 Assign No:

Estimate

2/19/2016

Vehicle Information	Owner - Andys Rent A Car	Accident Location
005 Suzuki Liana	West Bay, KY1-1	
Style: 4-Door Car	Work Phone: 949-8111	
Color:	Work Phone:	Phone #1:
Color Code:	Fax #:	Phone #2:
Production Date: / / 0	Insured -	Claimant -
License: 155924 State:		
VIN: RA31S-250047		
Miles In: 0	Home Phone:	Home Phone:
Miles Out: 0	Work Phone:	Work Phone:
Condition:	Fax #:	Fax #:
Estimator: Gerald Parsons	Date of Loss: 2/18/2016	Date of Inspection: 2/18/2016
Date Assigned: 2/18/2016		

Description of Work	Part Number	Price	Labor	Paint	Other
* This Vehicle Was Inspected Found To Be Beyond Economical Repair					

	Sub Totals		
	Hours	Rate	Total
	<u>Tax</u>	<u>Non-Taxed</u>	
	Grand Total		

IN BUSINESS SINCE '83
 STATE LICENSE # 10237

THANK YOU FOR LETTING US SERVE YOU

T Indicates Taxed Item

Vehicle Solutions, Equip. and Services

George Town, Grand Cayman
 PO Box 12415, KY1- 1010
 345 917 2222

Invoice

Date	Invoice #
3/9/2016	1610462

Bill To
Andys Rent a Car Attn Lema

PAID

P.O. No.	Terms	Project

Quantity	Description	Rate	Amount
	Automotive Appraisal for 2005 Suzuki Liana 155 924	100.00	100.00
		Total	\$100.00

ROYAL CAYMAN ISLANDS POLICE SERVICE

RECEIPT
NUMBER



RCIPS
We Care, We Listen and We Act

APPLICATION FOR TRAFFIC ACCIDENT REPORT

((PLEASE NOTE, THE RECEIPT NUMBER "MUST BE WRITTEN" ON THE TOP OF THIS REQUEST, PRIOR TO SUBMITTING TO THE CRIME DESK FOR PROCESS))

Date Requested: 03/09/16.

Requesting Person: Giselle Harford.

Registered Own of Vehicle: Andy's Rent a Car.

Person Driving the Vehicle: Jordana Jordan.

Date Of Accident: 02/13/16.

Vehicle Reg. # 155924.

Investigating Officers Name: Brown, Emmanuel.

Location of Accident: Traffic light by Jacques Scott.

Phone #: 927-4040

Detective Sergeant Jessie Melbourne
Crime Desk Manager
Royal Cayman Islands Police

This is my :

First Request

Second Request

Purpose Requested:

Legal Purpose

Insurance

Other _____

Regards,

Signature

FOR OFFICE USE ONLY:

Please note a \$100.00 charge is applicable with this application, reports are printed on Wednesdays & Thursdays of each week.

Date Completed: _____ By Whom Completed: _____

Signature: _____

VEHICLE SOLUTIONS
Crash Analysis, Inspections, Radars and more

Vehicle Appraisal Form

Date 08/03/16

Day Tuesday

Reg Owner: Andy's Rent a car

Address #

Ph

Insurance Company

Claim

Requested by: Andy's

Make Suzuki

Model Liana

Year 2005

LHD / RHD

Market: Japan

VIN/Frame RA31S250047

Reg # 155 924

Color Blue

Mileage 53,981

Body Style: Sedan

Drive FWD

Engine

Trans Auto

Bodywork: (pre collision) Paint: See Comments

Interior:

Condition:

Seats: Leather / Vinyl / Cloth

of Pass: 5

Options: Stereo / MP3 / CD / DVD / CD Changer Wood Trim Y/N Sunroof Y/N

Airbags: Driver / Passenger / L&R Side Curtain / Seats / Bolster A/C: Y / N Works: Y / N

ABS: Y / N Stability Control: Y / N Traction Control Y/N

Rims: Factory Steel w/ Hubcaps

Tires: Average Condition

Modifications:

Comments: The paint is in good condition for the model year and the interior is in average condition seats need cleaning.







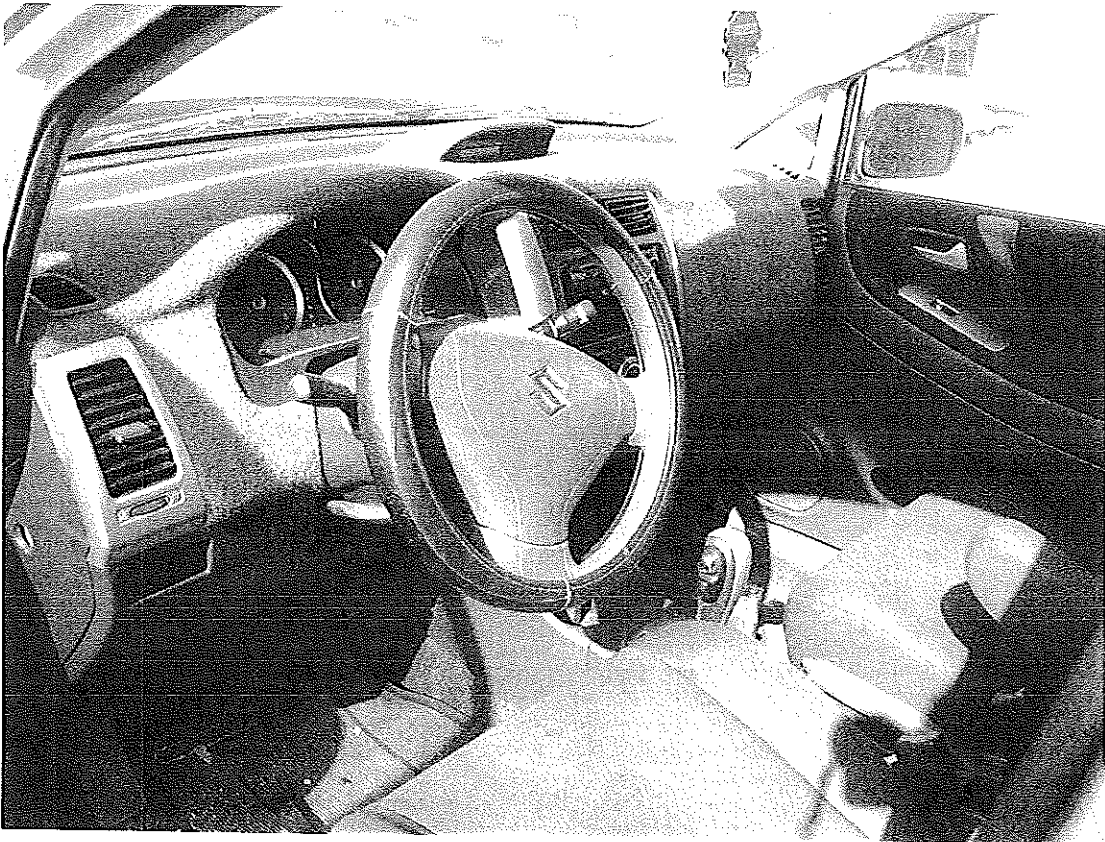
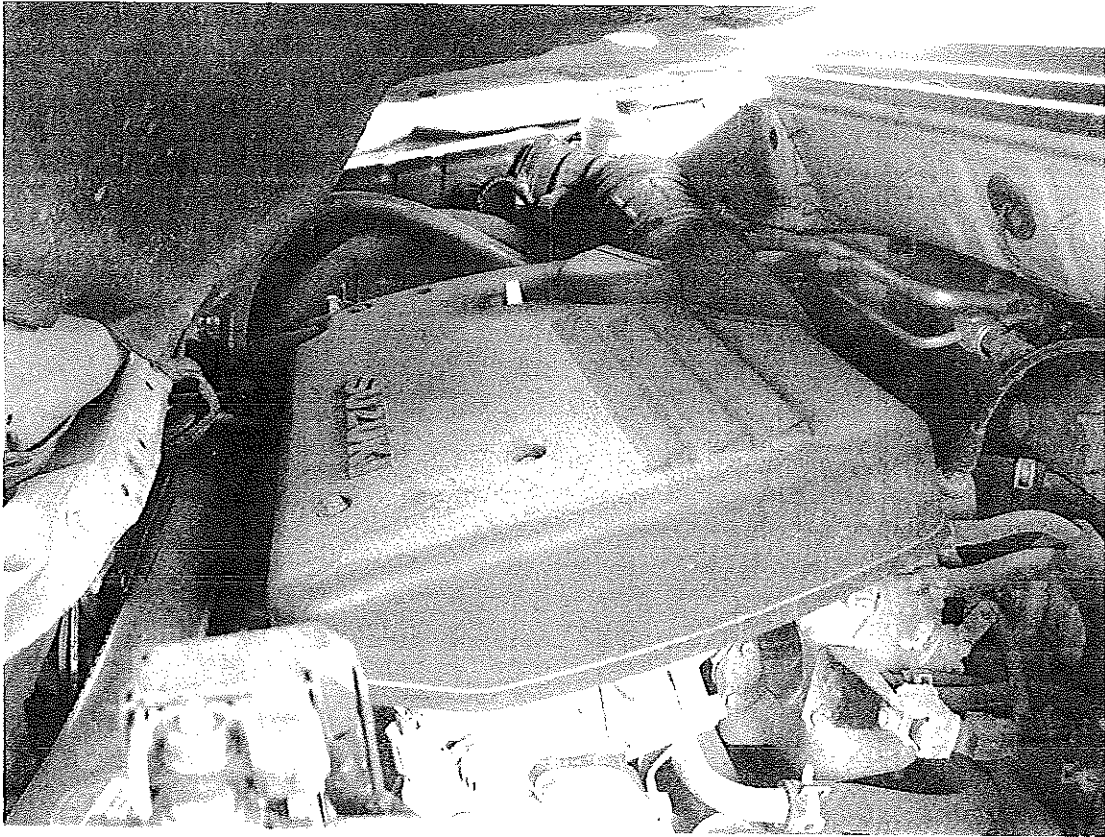

Costs involved

Fair Market Value not taking into account the collision damages to the

Current value = CI\$ 6,000.00

**Repair Costs =
Difference \$**

Salvage value suggested \$1000.00

C. Redden

Collin Redden
Radar Expert, Accident Reconstructionist,
Post Crash Vehicle Inspector, Crash Analyst
Expert Witness ARC/CSI Member # 1525
CDR Technician Level 2, NAPARS Member
Auto / Equip Appraiser

Cost values are based on sources such as the Kelly Blue Book, Edmunds and other sources and research based on the type and year and condition of the vehicle being appraised.

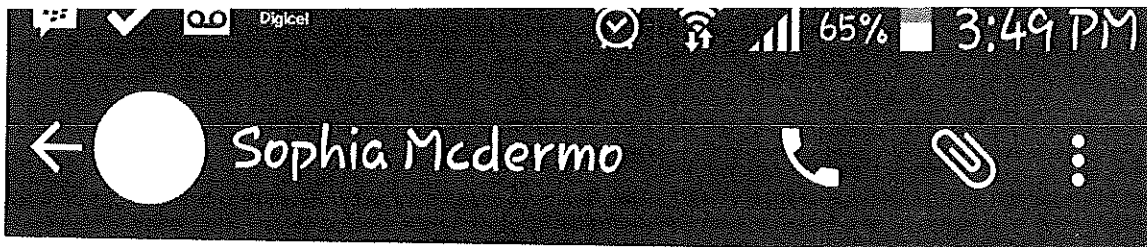

MARCH 9, 2016

Hello this is Giselle from andys 2:35 PM ✓✓

MARCH 22, 2016

Good afternoon sophia was wondering if i would be able to come in or can u send me pics of ur car 12:16 PM ✓✓

MARCH 29, 2016

Good afternoon sophia are u able to come by today 11:11 AM ✓✓

MARCH 30, 2016

Good morning ms sophia would u be able to come by today 11:06 AM ✓✓

I will try today

Ok hope to see u soon 1:20 PM ✓✓

MARCH 31, 2016

... ..



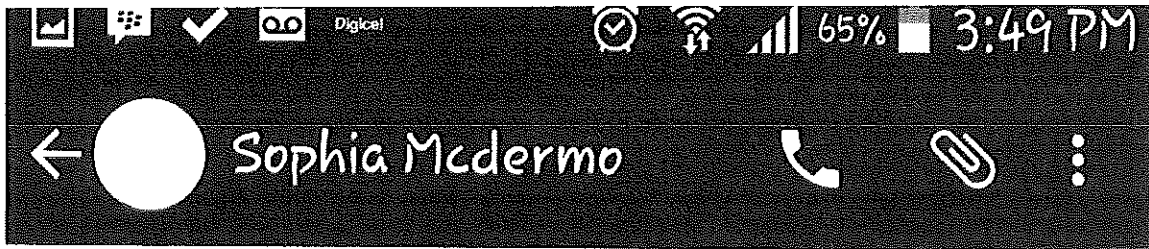

Good morning ms sophia would u be able to come by today

11:00 AM ✓✓

I will try today

Ok hope to see u soon

11:10 AM ✓✓

MARCH 31, 2016

What time u close

Close at 5 sorry i was not in office today..will be in tomorrow from 8am to 1pm

5:07 PM ✓✓

Ok I will try my best to com in between that time

YESTERDAY

Messages you send to this chat and calls are now secured with end-to-end encryption. Tap for more info.

TODAY - 6th April, 2016 .

Good afternoon sophia r u able to come in tomorrow or friday this week

1:04 PM ✓✓

